



■ Features

- Universal AC input / Full range
- Withstand 300VAC surge input for 5 seconds
- Low profile:26mm
- Built-in active PFC function
- Fanless design, cooling by free air convection
- Protections: Short circuit / Overload / Over voltage / Over temperature
- Low leakage current<1.0mA
- LED indicator for power on
- 3 years warranty

■ Applications

- LED signage display
- Moving sign
- LED channel letter
- LED TV wall

■ Description

UHP-200A series is a 200W LED display power solution. The ultra low profile design that allows the height and weight of the sign module to be slim. It greatly simplifies the delivery and installation process. Accounting for high efficiency and energy saving, the series effectively achieves electricity reduction. It is suitable for LED signage display, moving sign, LED channel letter and LED TV wall etc.

■ Model Encoding

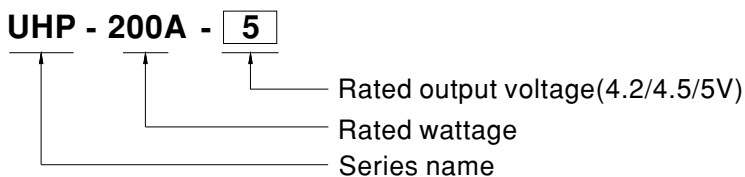



SPECIFICATION

MODEL		UHP-200A-4.2	UHP-200A-4.5	UHP-200A-5
OUTPUT	DC VOLTAGE	4.2V	4.5V	5V
	RATED CURRENT	40A	40A	40A
	CURRENT RANGE	0~40A	0~40A	0~40A
	RATED POWER _(convection)	168W	180W	200W
	RIPPLE & NOISE _(max.) Note.2	200mVp-p	200mVp-p	200mVp-p
	VOLTAGE ADJ. RANGE	4.0~4.4V	4.3~4.7V	4.7~5.3V
	VOLTAGE TOLERANCE Note.3	±4.0%	±4.0%	±4.0%
	LINE REGULATION	±0.5%	±0.5%	±0.5%
	LOAD REGULATION	±2.5%	±2.5%	±2.5%
	SETUP, RISE TIME	2000ms, 200ms/230VAC at full load, 3000ms, 200ms/115VAC at 80% load		
	HOLD UP TIME (Typ.)	10ms/230VAC 10ms/115VAC		
DC OK FUNCTION	PSU Turns on:DC ok; PSU turns off:DC fail			
INPUT	VOLTAGE RANGE Note.4	90 ~ 264VAC 127 ~ 370VDC		
	FREQUENCY RANGE	47 ~ 63Hz		
	POWER FACTOR (Typ.)	PF ≥ 0.97/115VAC PF ≥ 0.95/230VAC at full load		
	EFFICIENCY (Typ.)	88%	88%	88.5%
	AC CURRENT (Typ.)	2.4A/115VAC 1.2A/230VAC		
	INRUSH CURRENT (Typ.)	Cold start 85A/230VAC		
	LEAKAGE CURRENT	<1.0mA / 240VAC		
PROTECTION	OVERLOAD	110~140% rated output power Protection type : Hiccup mode, recovers automatically after fault condition is removed		
	SHORT CIRCUIT	Protection type : Hiccup mode, recovers automatically after fault condition is removed		
	OVER VOLTAGE	4.6 ~ 6V	5 ~ 6.4V	5.6 ~ 7.1V
	OVER TEMPERATURE	Protection type : Shut down O/P voltage, recovers automatically after fault condition is removed		
ENVIRONMENT	WORKING TEMP.	-30 ~ +70°C (Refer to "OUTPUT LOAD vs TEMPERATURE")		
	WORKING HUMIDITY	20 ~ 90% RH non-condensing		
	STORAGE TEMP., HUMIDITY	-40 ~ +85°C, 10 ~ 95% RH		
	TEMP. COEFFICIENT	±0.03%/°C (0 ~ 50°C)		
	VIBRATION	10 ~ 500Hz, 5G 10min./1cycle, 60min. each along X, Y, Z axes		
SAFETY & EMC (Note.5)	SAFETY STANDARDS	UL60950-1,TUV EN60950-1,CCC GB4943, EAC TP TC 004 approved		
	WITHSTAND VOLTAGE	I/P-O/P:3.0KVAC I/P-FG:2KVAC O/P-FG:0.5KVAC		
	ISOLATION RESISTANCE	I/P-O/P, I/P-FG, O/P-FG:100M Ohms/500VDC/25°C / 70%RH		
	EMC EMISSION Note.8	Compliance to EN55032 (CISPR32),GB9254,Class A, EN61000-3-2,-3,GB17625.1,EAC TP TC 020		
	EMC IMMUNITY	Compliance to EN61000-4-2,3,4,5,6,8,11;EN55024, light industry level (surge 4KV),EAC TP TC 020		
OTHERS	MTBF	204K hrs min. MIL-HDBK-217F (25°C)		
	DIMENSION	167*55*26mm (L*W*H)		
	PACKING	0.42kg; 20pcs/ 11.4kg/0.76CUFT		
NOTE	<p>1. All parameters NOT specially mentioned are measured at 230VAC input, rated load and 25°C of ambient temperature.</p> <p>2. Ripple & noise are measured at 20MHz of bandwidth by using a 12" twisted pair-wire terminated with a 0.1uf & 47uf parallel capacitor.</p> <p>3. Tolerance : line regulation and load regulation.</p> <p>4. Derating may be needed under low input voltages. Please check the static characteristics for more details.</p> <p>5. Length of set up time is measured at cold first start. Turning ON/OFF the power supply may lead to increase of the set up time.</p> <p>6. Transient response measure shall be made with 10% load at least.</p> <p>7. The power supply is considered a component which will be installed into a final equipment. All the EMC tests are been executed by mounting the unit on a 360mm*360mm metal plate with 1mm of thickness. The final equipment must be re-confirmed that it still meets EMC directives. For guidance on how to perform these EMC tests, please refer to "EMI testing of component power supplies." (as available on http://www.meanwell.com)</p> <p>8. Warning: This equipment is compliant with Class A of CISPR 32. In a residential environment may cause radio interference.</p>			

Block Diagram

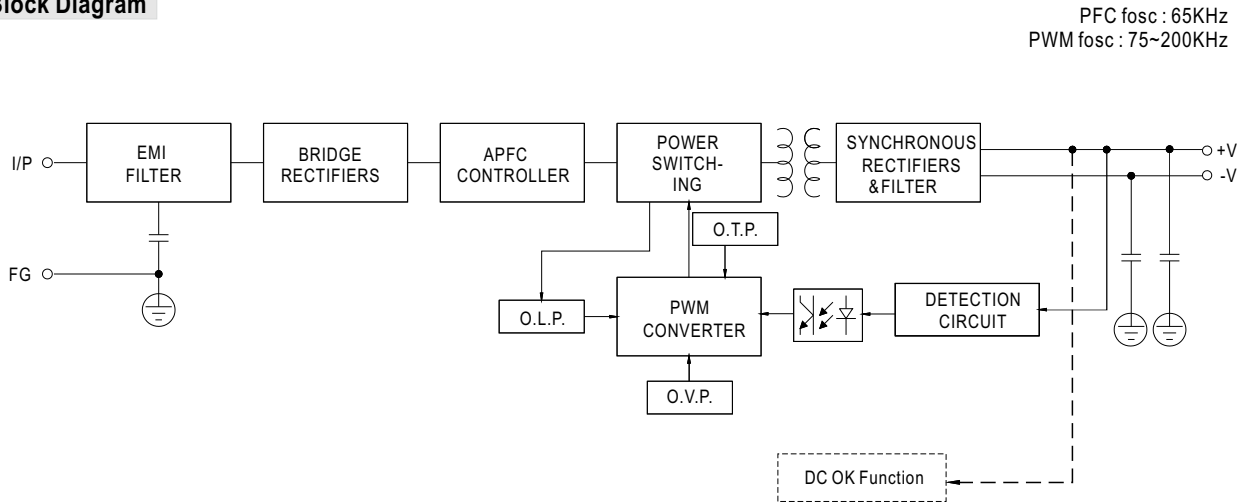

OUTPUT LOAD vs TEMPERATURE

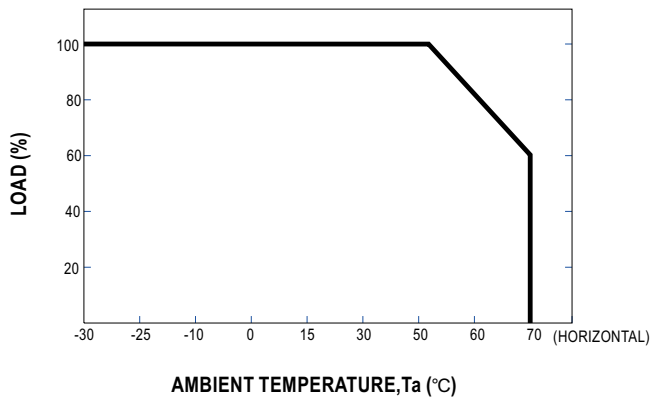

STATIC CHARACTERISTIC

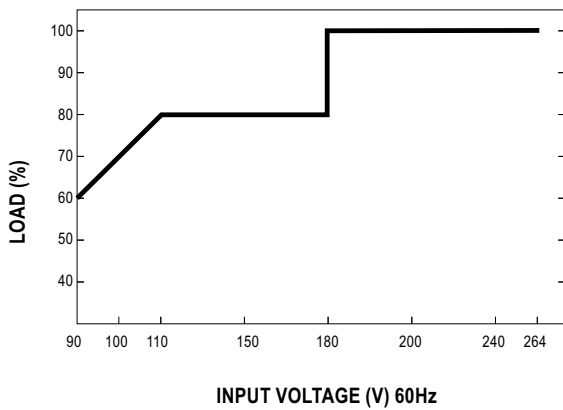

Mechanical Specification

CASE NO.: 249A Unit:mm

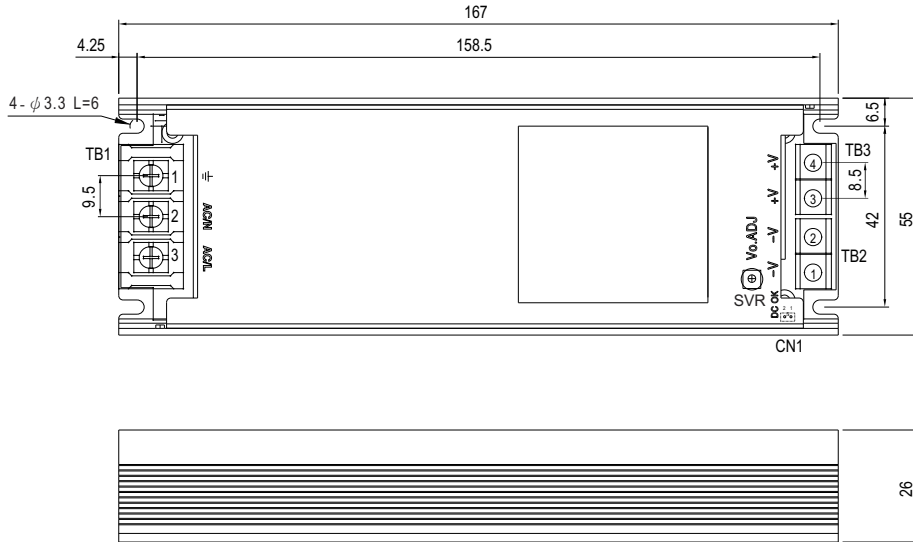

AC Input Terminal(TB1) pin NO. Assignment

Pin No.	Assignment	Terminal	Max mounting torque
1	AC/L	(DECA) T14-EM11033703	13Kgf-cm
2	AC/N		
3	⊕		

DC Output Terminal(TB2, TB3) pin NO. Assignment

Pin No.	Assignment	Terminal	Max mounting torque
1,2	-V	(MW)	8Kgf-cm
3,4	+V	TB-HTP-200-40A	

DC OK Connector(CN1):JST B2B-PH-K-S or equivalent

Pin No.	Assignment	Mating Housing	Terminal
1	DC OK +V	JST PHR-2 or equivalent	JST SPH-002T-P0.5S or equivalent
2	DC COM		

Function manual

1.Internal circuit of DC ok

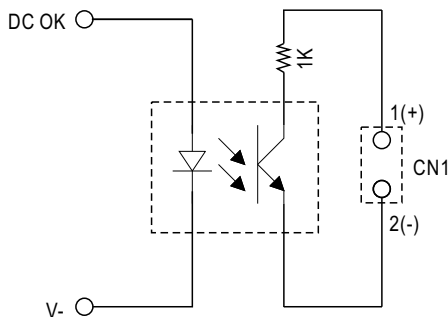

Contact Close	PSU turns on	DC ok
Contact Open	PSU turns off	DC fail
Contact Rating(max.)	10Vdc/1mA	

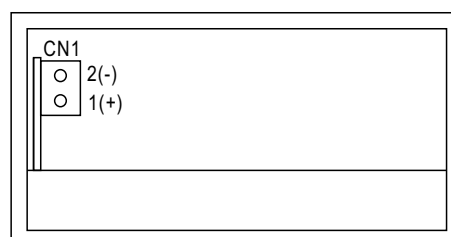

■ Installation

1. Operate with additional aluminum plate

In order to meet the "Derating Curve" and the "Static Characteristics", UHP-200A series must be installed onto an aluminum plate (or the cabinet of the same size) on the bottom. The size of the suggested aluminum plate is shown as below. And for optimizing thermal performance, the aluminum plate must have an even and smooth surface (or coated with thermal grease), and UHP-200A series must be firmly mounted at the center of the aluminum plate.

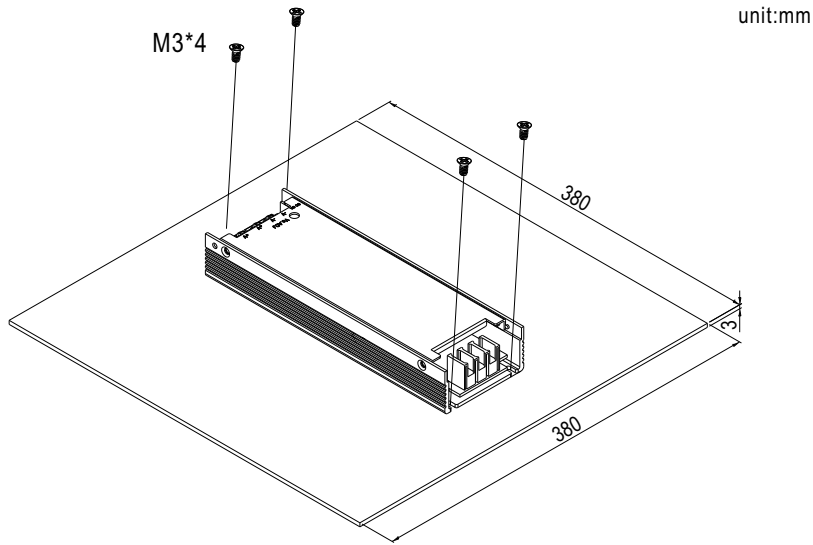

2. For heat dissipation, at least 5cm installation distance around the PSU should be kept, shown as below:

